



**5 3 3 1**

**Transmetteur 2-fils  
universel (Pt100/TC)**

No 5331V114-FR

A partir du no de série 141365001



**IECEX**



**CCOE**

**ATEX**



**ERC** **CE**

## Revision Notes

The following list provides notes concerning revisions of this document.

| <b>Rev. ID</b> | <b>Date</b> | <b>Notes</b>  |
|----------------|-------------|---|
| 113            | 13/45       | IECEX and INMETRO approvals added                                       |
| 114            | 15/10       | PESO/CCOE approval added<br>GOST approval replaced with<br>EAC approval |

# TRANSMETTEUR 2-FILS UNIVERSEL (Pt100/TC)

5331

## SOMMAIRE

|  |    |
|--|----|
| Application.....                             | 2  |
| Caractéristiques techniques.....             | 2  |
| Montage / installation.....                  | 2  |
| Applications.....                            | 3  |
| Référence: 5331.....                         | 4  |
| Spécifications.....                          | 4  |
| Connexions.....                              | 8  |
| Schéma de principe.....                      | 9  |
| Programmation.....                           | 10 |
| Dimensions mécaniques.....                   | 11 |
| Montage des fils du capteur.....             | 11 |
| Appendix.....                                | 12 |
| ATEX Installation Drawing - 5331A.....       | 13 |
| ATEX Installation Drawing - 5331D.....       | 14 |
| IECEX Installation Drawing - 5331A.....      | 16 |
| IECEX Installation Drawing - 5331D.....      | 17 |
| FM Installation Drawing - 5331D.....         | 19 |
| CSA Installation Drawing - 5331D.....        | 21 |
| INMETRO Instruções de Segurança - 5331A..... | 23 |
| INMETRO Instruções de Segurança - 5331D..... | 24 |

# TRANSMETTEUR 2-FILS UNIVERSEL (Pt100/TC) 5331

- *Entrée RTD, TC, Ohm ou mV*
- *Très grande précision de mesure*
- *Isolation galvanique de 1,5 kVAC*
- *Sécurité programmable*
- *Pour tête de sonde DIN B*

## Application

- Mesure linéarisée de la température avec un capteur Pt100...Pt1000, Ni100... Ni1000 ou de thermocouples.
- Conversion d'une résistance linéaire en un signal courant standard analogique pour mesurer par exemple le niveau ou la position d'une vanne.
- Amplification d'un signal mV bipolaire en un signal courant standard de 4...20 mA.

## Caractéristiques techniques

- Le PR5331 peut être programmé de manière simple et rapide.
- Compensation de ligne pour des entrées RTD et résistance avec un raccordement à 2, 3 et 4 fils.
- Vérification continue des données sauvegardées.

## Montage / installation

- Pour tête de sonde DIN B. En zone non-dangereuse le 5331 peut être monté sur rail DIN avec le support PR type 8421.

# APPLICATIONS

RTD en 4...20 mA

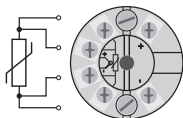

Installation 2-fils  
en salle de contrôle



TC en 4...20 mA

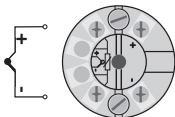

Installation 2-fils  
en salle de contrôle

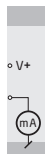

Résistance  
4...20 mA

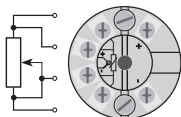

Installation 2-fils  
en salle de contrôle

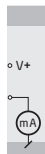

mV en 4...20 mA

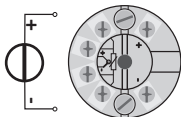

Installation 2-fils  
en salle de contrôle

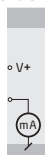

Référence: 5331

| Type | Version   | Température ambiante | Isolation galvanique |
|------|---|----------------------|----------------------|
| 5331 | Standard : A<br>CSA, FM, ATEX,<br>IECEX & INMETRO : D | -40°C...+85°C : 3    | 1500 Vca : B         |

## Spécifications

### Plage de température:

-40°C à +85°C

### Spécifications communes:

Tension d'alimentation, cc

Standard ..... 7,2...35 V

CSA, FM, ATEX, IECEX & INMETRO ..... 7,2...30 Vcc

Consommation interne ..... 25 mW...0,8 W

Chute de tension ..... 7,2 Vcc

Tension d'isolation, test / opération ..... 1,5 kVca / 50 Vca

Temps de chauffe ..... 5 min.

Kit de programmation ..... Loop Link

Rapport signal / bruit ..... Min. 60 dB

Temps de réponse (programmable) ..... 1...60 s

Vérification de l'EEPROM ..... < 3,5 s

Dynamique du signal d'entrée ..... 20 bit

Dynamique du signal de sortie ..... 16 bit

Température d'étalonnage ..... 20...28°C

Précision, la plus grande des valeurs générales et de base:

| Valeurs générales |                   |                            |
|-------------------|-------------------|----------------------------|
| Type d'entrée     | Précision absolue | Coefficient de température |
| Tous              | ≤ ±0,05% de l'EC  | ≤ ±0,01% de l'EC / °C      |

| Valeurs de base                 |                                |  |
|---------------------------------|--------------------------------|--|
| Type d'entrée                   | Précision de base              | Coefficient de température                         |
| RTD                             | $\leq \pm 0,2^{\circ}\text{C}$ | $\leq \pm 0,01^{\circ}\text{C}/^{\circ}\text{C}$   |
| Rés. linéaire                   | $\leq \pm 0,1 \Omega$          | $\leq \pm 10 \text{ m}\Omega / ^{\circ}\text{C}$   |
| Volt                            | $\leq \pm 10 \mu\text{V}$      | $\leq \pm 1 \mu\text{V} / ^{\circ}\text{C}$        |
| Type TC:<br>E, J, K, L, N, T, U | $\leq \pm 1^{\circ}\text{C}$   | $\leq \pm 0,05^{\circ}\text{C} / ^{\circ}\text{C}$ |
| Type TC: B, R, S,<br>W3, W5, LR | $\leq \pm 2^{\circ}\text{C}$   | $\leq \pm 0,2^{\circ}\text{C} / ^{\circ}\text{C}$  |

|                                     |                       |
|-------------------------------------|-----------------------|
| Immunité CEM .....                  | $< \pm 0,5\%$ de l'EC |
| Immunité CEM améliorée :            |                       |
| NAMUR NE 21, critère A, burst ..... | $< \pm 1\%$ de l'EC   |

|   |   |
|---|---|
| Effet d'une variation de la tension d'alimentation..... | $< 0,005\%$ de l'EC / Vcc               |
| Vibration .....   | IEC 60068-2-6 : 2007                    |
| 2...25 Hz .....   | $\pm 1,6 \text{ mm}$                    |
| 25...100 Hz .....                                       | $\pm 4 \text{ g}$                       |
| Taille max. des fils.....                               | 1 x 1,5 mm <sup>2</sup> fil multibrins  |
| Pression max. avant déformation de la vis .....         | 0,4 Nm                                  |
| Humidité .....  | $< 95\%$ HR (sans cond.)                |
| Dimensions .....  | $\varnothing 44 \times 20,2 \text{ mm}$ |
| Degré de protection (boîtier / bornier).....            | IP68 / IP00                             |
| Poids .....   | 50 g                                    |

### Spécifications électriques, entrée:

#### Entrée RTD et entrée résistance linéaire:

| Type RTD | Valeur min. | Valeur max.   | Plage min.  | Standard  |
|----------|-------------|---------------|-------------|-----------|
| Pt100    | -200°C      | +850°C        | 25°C        | IEC 60751 |
| Ni100    | -60°C       | +250°C        | 25°C        | DIN 43760 |
| R lin.   | 0 $\Omega$  | 5000 $\Omega$ | 30 $\Omega$ | -----     |

|   |                              |
|---|------------------------------|
| Décalage max.....                                 | 50% de la valeur max. sélec. |
| Résistance de ligne max. par fils .....           | 5 $\Omega$                   |
| Courant de sonde.....                             | Nom. 0,2 mA                  |
| Effet de la résistance de ligne (3 / 4 fils)..... | $< 0,002 \Omega/\Omega$      |
| Détection de rupture sonde .....                  | Oui                          |

**Entrée TC :**

| Type | Température min. | Température max. | Plage min. | Standard     |
|------|------------------|------------------|------------|--------------|
| B    | +400°C           | +1820°C          | 100°C      | IEC584       |
| E    | -100°C           | +1000°C          | 50°C       | IEC584       |
| J    | -100°C           | +1200°C          | 50°C       | IEC584       |
| K    | -180°C           | +1372°C          | 50°C       | IEC584       |
| L    | -100°C           | +900°C           | 50°C       | DIN 43710    |
| N    | -180°C           | +1300°C          | 50°C       | IEC584       |
| R    | -50°C            | +1760°C          | 100°C      | IEC584       |
| S    | -50°C            | +1760°C          | 100°C      | IEC584       |
| T    | -200°C           | +400°C           | 50°C       | IEC584       |
| U    | -200°C           | +600°C           | 50°C       | DIN 43710    |
| W3   | 0°C              | +2300°C          | 100°C      | ASTM E988-90 |
| W5   | 0°C              | +2300°C          | 100°C      | ASTM E988-90 |
| LR   | -200°C           | +800°C           | 50°C       | GOST 3044-84 |

Décalage max..... 50% de la valeur max. sélec.

Compensation de soudure froide..... < ±1,0°C

Détection de rupture de sonde..... Oui

Courant de sonde :

Pendant la détection ..... Nom. 33 µA

Si non ..... 0 µA

**Entrée tension :**

Gamme de mesure..... -12...800 mV

Plage de mesure min..... 5 mV

Décalage max..... 50% de la valeur max. sélec.

Résistance d'entrée ..... 10 MΩ

**Sortie :****Sortie courant :**

Gamme de mesure..... 4...20 mA

Plage de mesure min..... 16 mA

Temps de scrutation..... 440 ms

Sortie en cas de corruption de l'EEPROM..... ≤ 3,5 mA

Résistance de charge..... ≤ (V<sub>alim.</sub> - 7,2) / 0,023 [Ω]

Stabilité de charge..... < ±0,01% de l'EC / 100 Ω

**Détection de rupture de sonde :**

Programmable ..... 3,5...23 mA

NAMUR NE43 Haut d'échelle..... 23 mA

NAMUR NE43 Bas d'échelle..... 3,5 mA

EC = Echelle configurée



**Approbations :**

|           |                |
|-----------|----------------|
| CEM ..... | 2004/108/CE    |
| CCOE..... | P337392/1      |
| EAC ..... | TR-CU 020/2011 |

**Approbation marine :**

Det Norske Veritas, Ships & Offshore ..... Stand. f. Certific. No. 2.4

**Ex / S.I. :**

## ATEX 94/9/CE

|                             |                      |
|-----------------------------|----------------------|
| 5331A.....                  | KEMA 10ATEX0002 X    |
| 5331D.....                  | KEMA 06ATEX0062 X    |
| Certificat FM.....          | 2D5A7                |
| Certificat CSA.....         | 1125003              |
| IECEX.....                  | DEK 13.0035X         |
| INMETRO.....                | DEKRA 13.0001 X      |
| CCOE.....                   | P337392/2            |
| EAC Ex TR-CU 012/2011 ..... | RU C-DK.GB08.V.00410 |

# CONNEXIONS

## Entrée :

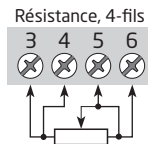
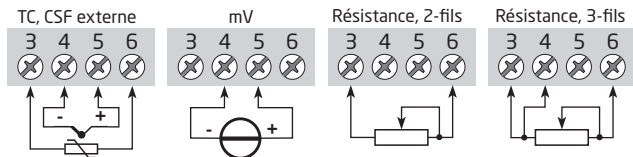
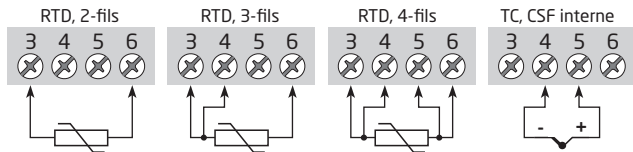

## Sortie :

Installation 2-fils

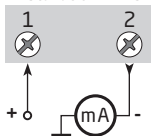

# SCHEMA DE PRINCIPE

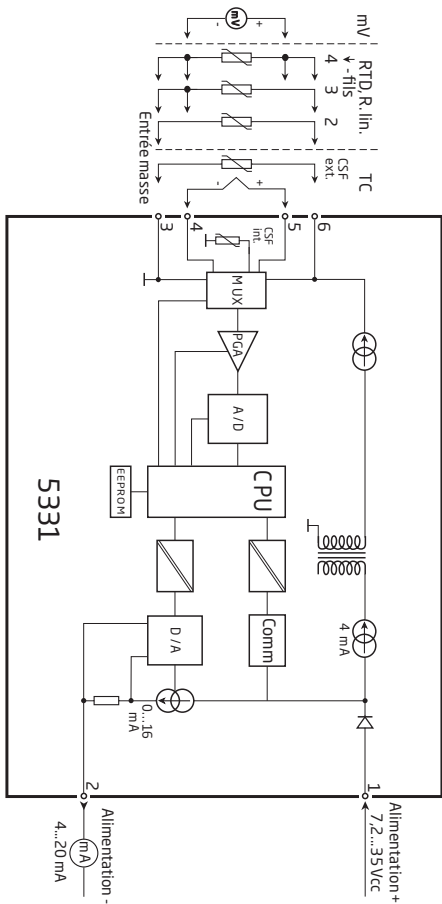

# PROGRAMMATION

- Loop Link est un kit de programmation permettant de programmer le 5331.
- Pour le raccordement du Loop Link, veuillez vous reporter au schéma ci-dessous et à l'aide en ligne du logiciel PRreset.
- Loop Link ne doit pas être utilisé pour communication avec des modules installés en zone dangereuse.

## Numéro de référence: Loop Link

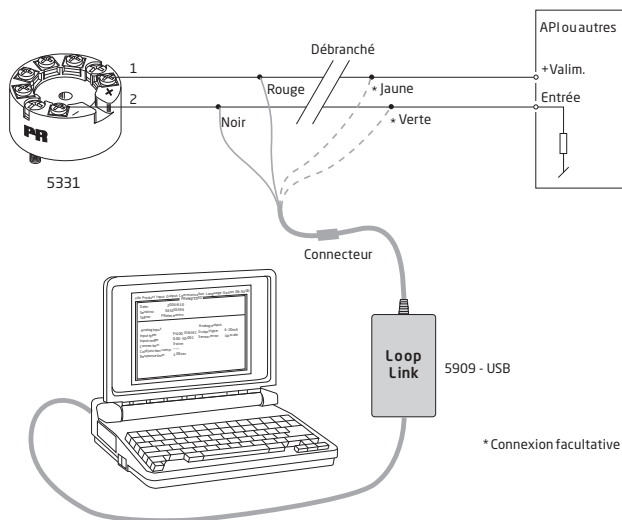

## Dimensions mécaniques

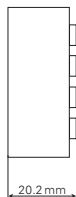
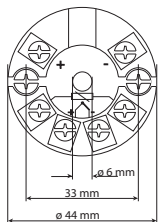

## Montage des fils du capteur

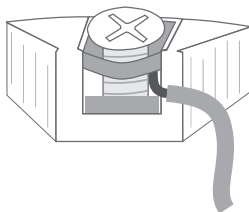

Les fils doivent être montés entre les plaques métalliques.

# APPENDIX

**ATEX Installation Drawing - 5331A**

**ATEX Installation Drawing - 5331D**

**IECEX installation drawing - 5331A**

**IECEX installation drawing - 5331D**

**FM Installation Drawing - 5331D**

**CSA Installation Drawing - 5331D**

**INMETRO Instruções de Segurança - 5331A**

**INMETRO Instruções de Segurança - 5331D**

## Schéma d'installation ATEX

Pour une installation sûre du 5331A3B ou du 5334A3B vous devez observer ce qui suit. Le module sera seulement installé par un personnel qualifié qui est informé des lois, des directives et des normes nationales et internationales qui s'appliquent à ce secteur. L'année de la fabrication est indiquée dans les deux premiers chiffres dans le numéro de série.

Certificat ATEX      KEMA 10ATEX 0002 X

Marquage            II 3 G Ex nA [ic] IIC T4 ... T6 Gc  
 II 3 G Ex ic IIC T4...T6 Gc  
 II 3 D Ex ic IIIC Dc

Standards      EN 60079-0 : 2012, EN 60079-11 : 2012, EN 60079-15 : 2010

T4:  $-40 \leq T_a \leq 85^\circ\text{C}$   
 T6:  $-40 \leq T_a \leq 60^\circ\text{C}$

**Bornes : 3,4,5,6**  
 Ex nA [ic]

**Bornes : 1,2**  
 Ex nA

**Bornes : 1,2**  
 Ex ic

Uo: 9,6 V  
 Io: 25 mA  
 Po: 60 mW  
 Lo: 33 mH  
 Co: 2,4  $\mu\text{F}$

Umax.  $\leq 35 \text{ Vcc}$

Ui = 35 Vcc  
 Ii = 110 mA  
 Li = 10  $\mu\text{H}$   
 Ci = 1,0 nF

### Conditions spécifiques à l'utilisation sûre :

Pour le type de protection Ex nA, le transmetteur doit être installé dans un boîtier de protection assurant un degré d'étanchéité d'au moins IP54 conformément à l'EN 60529.

Pour utilisation dans la présence de poussières combustibles, le transmetteur doit être installé dans un boîtier de protection assurant un degré d'étanchéité d'au moins IP6X conformément à l'EN 60529. La température de surface du boîtier doit être déterminée après l'installation des unités. La température de surface du boîtier est de 20 K au dessus de la température ambiante.

Pour une température ambiante  $\geq 60^\circ\text{C}$ , il faut utiliser des câbles résistant aux températures élevées avec une capacité nominale d'au moins 20 K au dessus de la température ambiante.

## Schéma d'installation ATEX



Pour une installation sûre du 5331D ou 5334B vous devez observer ce qui suit. Le module sera seulement installé par un personnel qualifié qui est informé des lois, des directives et des normes nationales et internationales qui s'appliquent à ce secteur.

L'année de la fabrication est indiquée dans les deux premiers chiffres dans le numéro de série.

Certificat ATEX KEMA 06ATEX 0062 X

Marquage  II 1 G Ex ia IIC T4...T6 Ga  
II 1 D Ex ia IIIC Da  
I M1 Ex ia I Ma

Standards EN 60079-0 : 2012, EN 60079-11 : 2012, EN 60079-26 : 2007,  
EN 60079-15 :2010

Zone dangereuse  
Zone 0, 1, 2, 20, 21, 22

T4:  $-40 \leq T_a \leq 85^\circ\text{C}$

T6:  $-40 \leq T_a \leq 60^\circ\text{C}$

**Bornes : 3,4,5,6**

Uo: 9,6 Vcc

Io: 25 mA

Po: 60 mW

Lo: 33 mH

Co: 2,4µF

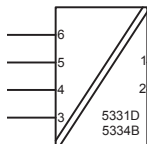

**Bornes : 1,2**

Ui: 30 Vcc

Ii: 120 mA

Pi: 0,84 W

Li: 10µH

Ci: 1,0nF

Zone non dangereuse

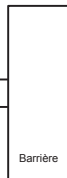



**Notes d'installation**

L'isolation galvanique entre le circuit du capteur et le circuit d'entrée n'est pas infaillible. Cependant, l'isolation galvanique entre les circuits est capable de résister à une tension de test de 500 Vca pendant 1 minute.

Dans les atmosphères potentiellement explosibles dû à la présence de gaz, le transmetteur doit être installé dans un boîtier de protection assurant un degré d'étanchéité d'au moins IP20 conformément à l'EN 60529.

Pour les installations dans les atmosphères explosibles exigeant des appareils de catégorie 1 G, 1 M ou 2 M, et dans le cas où le boîtier est fait d'aluminium, le boîtier doit être installé dans une telle manière que, même dans le cas d'incidents rares, les sources d'inflammation dues aux impacts et aux étincelles de friction ne peuvent se produire; dans le cas où le boîtier est fait de matériaux non métalliques, les décharges électrostatiques sur le boîtier du transmetteur doivent être évitées.

Pour les installations dans les atmosphères potentiellement explosibles dû à la présence de poussières combustibles on doit observer ce qui suit :

Le transmetteur monté dans un boîtier métallique DIN B conformément à DIN 43729. Ce boîtier doit assurer un degré d'étanchéité d'au moins IP 6X conformément à l'EN 60529 et il doit convenir à l'application et être correctement installé.

Seulement des raccords de câble et des bouchons convenant à l'application et correctement installés doivent être utilisés.

Pour une température ambiante  $\geq 60^{\circ}\text{C}$ , il faut utiliser des câbles résistant aux températures élevées avec une capacité nominale d'au moins 20 K au dessus de la température ambiante.

La température superficielle du boîtier égale la température ambiante plus 20K, pour une couche de poussière d'une épaisseur jusqu'à 5 mm.

## IECEx Installation drawing



For safe installation of 5331A or 5334A the following must be observed. The module shall only be installed by qualified personnel who are familiar with the national and international laws, directives and standards that apply to this area.  
Year of manufacture can be taken from the first two digits in the serial number.

|             |  |
|-------------|--|
| Certificate | IECEx DEK 13.0035X   |
| Marking     | Ex nA [ic] IIC T4..T6 Gc<br>Ex ic IIC T4..T6 Gc<br>Ex ic IIIC Dc |
| Standards   | IEC 60079-0 : 2011, IEC 60079-11 : 2011, IEC 60079-15 : 2010     |

|  |                          |                      |                       |
|--|--------------------------|----------------------|-----------------------|
| T4: $-40 \leq T_a \leq 85^\circ\text{C}$ | <b>Terminal: 3,4,5,6</b> | <b>Terminal: 1,2</b> | <b>Terminal: 1,2</b>  |
| T6: $-40 \leq T_a \leq 60^\circ\text{C}$ | Uo: 9.6 V                | Ex nA                | Ex ic                 |
|  | Io: 25 mA                |                      |                       |
|  | Po: 60 mW                | Umax =35 VDC         | Ui = 35 VDC           |
|  | Lo: 33 mH                |                      | Ii = 110mA            |
|  | Co: 2.4 $\mu\text{F}$    |                      | Li = 10 $\mu\text{H}$ |
|  |                          |                      | Ci = 1.0 nF           |

### Installation note:

For installation in a potentially explosive gas atmosphere, the following instructions apply:  
For nA installation the transmitter must be installed in a metal enclosure, e.g. a form B enclosure providing a degree of protection of at least IP54 according to IEC60529 or in an enclosure with type of protection Ex n or Ex e.

For ic installation the transmitter must be installed in enclosure providing a degree of protection of at least IP20 according to IEC60529 and that is suitable for the application.

Cable entry devices and blanking elements shall fulfill the same requirements  
For an ambient temperature  $\geq 60^\circ\text{C}$ , heat resistant cables shall be used with a rating of at least 20 K above the ambient temperature.

For installation in a potentially explosive dust atmosphere, the following instructions apply:  
The surface temperature of the enclosure is equal to the ambient temperature plus 20 K, for a dust layer with a thickness up to 5 mm.  
The transmitter must be mounted in a enclosure according to DIN 43729 that provides a degree of protection of at least IP6X according to IEC60529, and that is suitable for the application. Cable entry devices and blanking elements shall fulfill the same requirements.

## IECEx Installation drawing



For safe installation of 5331D or 5334B the following must be observed. The module shall only be installed by qualified personnel who are familiar with the national and international laws, directives and standards that apply to this area.

Year of manufacture can be taken from the first two digits in the serial number.

|             |  |
|-------------|--|
| Certificate | IECEx DEK 13.0035X   |
| Marking     | Ex ia IIC T4...T6 Ga<br>Ex ia IIIC Da<br>Ex ia I Ma        |
| Standards   | IEC 60079-0 : 2011, IEC 60079-11 : 2011, IEC 60079-26:2006 |

### Hazardous area

Zone 0, 1, 2, 20, 21, 22, M1

T4:  $-40 \leq T_a \leq 85^\circ\text{C}$

T5:  $-40 \leq T_a \leq 60^\circ\text{C}$

T6:  $-40 \leq T_a \leq 45^\circ\text{C}$

### Terminal: 3,4,5,6

U<sub>o</sub>: 9.6 VDC

I<sub>o</sub>: 25 mA

P<sub>o</sub>: 60 mW

L<sub>o</sub>: 33 mH

C<sub>o</sub>: 2.4  $\mu\text{F}$

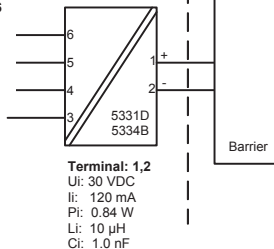

**Installation notes.**

The sensor circuit is not infallibly galvanic isolated from the input circuit. However, the galvanic isolation between the circuits is capable of withstanding a test voltage of 500Vac during 1 minute.

In a potentially explosive gas atmosphere, the transmitter shall be mounted in a metal form B enclosure in order to provide a degree of protection of at least IP20 according to IEC60529. If however the environment requires a higher degree of protection, this shall be taken into account.

If the transmitter is installed in an explosive atmosphere requiring the use of equipment protection level Ga, Ma and Mb, and if the enclosure is made of aluminum, it must be installed such, that ignition sources due to impact and friction sparks are excluded.

For installation in a potentially explosive dust atmosphere, the following instructions apply:

For explosive dust atmospheres, the surface temperature of the outer enclosure is 20 K above the ambient temperature.

The transmitter shall be mounted in a metal enclosure form B according to DIN43729 that is providing a degree of protection of at least IP6X according to IEC60529, that is suitable for the application and correctly installed.

Cable entries and blanking elements shall be used that are suitable for the application and correctly installed.

For an ambient temperature  $\geq 60^{\circ}\text{C}$ , heat resistant cables shall be used with a rating of at least 20 K above the ambient temperature.

## FM Installation Drawing 5300Q502 Rev AH

### Model 5331C, 5331D, 5333C, 5333D and 5343B

#### Hazardous (Classified) Location

Class I, Division 1, Groups, A, B, C, D T4..T6  
Class I, Zone 0, AEx ia IIC T4..T6

Ambient temperature limits  
T4: -40 to + 85 deg. Celsius  
T6: -40 to + 60 deg. Celsius

Terminal 1, 2  
Vmax or Ui: 30 V  
Imax or Ii: 120 mA  
Pmax or Pi: 0.84 W  
Ci: 1 nF  
Li: 10 uH

Terminal 3,4,5,6  
Vt or Uo: 9.6 V  
It or Io: 28 mA  
Pt or Po: 67.2 mW  
Ca or Co: 3.5 uF  
La or Lo: 35 mH

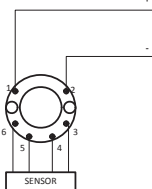

#### Non Hazardous Location

Associated Apparatus  
or Barrier  
with  
entity Parameters:

$UM \leq 250V$   
 $Voc \text{ or } Uo \leq Vmax \text{ or } Ui$   
 $Isc \text{ or } Io \leq Imax \text{ or } Ii$   
 $Po \leq Pi$   
 $Ca \text{ or } Co \geq Ci + Ccable$   
 $La \text{ or } Lo \geq Li + Lcable$

This device must not be connected  
to any associated apparatus which  
uses or generates more than 250  
Vrms

### Model 5335C, 5335D, 5336D, 5337D

#### Hazardous (Classified) Location

Class I, Division 1, Groups, A, B, C, D T4..T6  
Class I, Zone 0, AEx ia IIC T4..T6

Ambient temperature limits  
T4: -40 to + 85 deg. Celsius  
T6: -40 to + 60 deg. Celsius

Terminal 1, 2  
Vmax or Ui: 30 V  
Imax or Ii: 120 mA  
Pmax or Pi: 0.84 W  
Ci: 1 nF  
Li: 10 uH

Terminal 3,4,5,6  
Vt or Uo: 9.6 V  
It or Io: 28 mA  
Pt or Po: 67.2 mW  
Ca or Co: 3.5 uF  
La or Lo: 35 mH

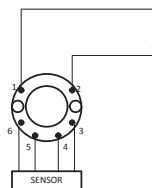

#### Non Hazardous Location

Associated Apparatus  
or Barrier  
with  
entity Parameters:

$UM \leq 250V$   
 $Voc \text{ or } Uo \leq Vmax \text{ or } Ui$   
 $Isc \text{ or } Io \leq Imax \text{ or } Ii$   
 $Po \leq Pi$   
 $Ca \text{ or } Co \geq Ci + Ccable$   
 $La \text{ or } Lo \geq Li + Lcable$

This device must not be connected  
to any associated apparatus which  
uses or generates more than 250  
Vrms

### The entity concept

The Transmitter must be installed according to National Electrical Code (ANSI-NFPA 70) and shall be installed with the enclosure, mounting, and spacing segregation requirement of the ultimate application.

Equipment that is FM-approved for intrinsic safety may be connected to barriers based on the ENTITY CONCEPT. This concept permits interconnection of approved transmitters, meters and other devices in combinations which have not been specifically examined by FM, provided that the agency's criteria are met. The combination is then intrinsically safe, if the entity concept is acceptable to the authority having jurisdiction over the installation.

The entity concept criteria are as follows:

The intrinsically safe devices, other than barriers, must not be a source of power.

The maximum voltage  $U_i(V_{MAX})$  and current  $I_i(I_{MAX})$ , and maximum power  $P_i(P_{MAX})$ , which the device can receive and remain intrinsically safe, must be equal to or greater than the voltage ( $U_o$  or  $V_{OC}$  or  $V_i$ ) and current ( $I_o$  or  $I_{SC}$  or  $I_i$ ) and the power  $P_o$  which can be delivered by the barrier.

The sum of the maximum unprotected capacitance ( $C_i$ ) for each intrinsically device and the interconnecting wiring must be less than the capacitance ( $C_a$ ) which can be safely connected to the barrier.

The sum of the maximum unprotected inductance ( $L_i$ ) for each intrinsically device and the interconnecting wiring must be less than the inductance ( $L_a$ ) which can be safely connected to the barrier.

The entity parameters  $U_o, V_{OC}$  or  $V_i$  and  $I_o, I_{SC}$  or  $I_i$ , and  $C_a$  and  $L_a$  for barriers are provided by the barrier manufacturer.

### NI Field Circuit Parameters

## Model 5331C, 5331D, 5333C, 5333D, 5335C, 5335D, 5336D, 5337D and 5343B

### Hazardous (Classified) Location

Class I, Division 2, Groups, A, B, C, D T4..T6  
Class I, Zone 2, IIC T4..T6

Ambient temperature limits  
T4: -40 to +85 deg. Celsius  
T6: -40 to +60 deg. Celsius

Terminal 1, 2  
 $V_{max}$  : 35 V  
C: 1.0 nF  
L: 10 uH

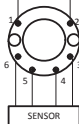

### Non Hazardous Location

Associated Apparatus  
or Barrier

This device must not be connected  
to any associated apparatus which  
uses or generates more than 250  
VRMS

## CSA Installation drawing 533XQC03

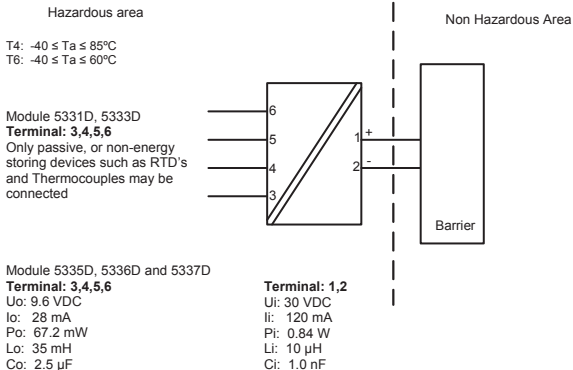

CLASS 2258 04 - PROCESS CONTROL EQUIPMENT - Intrinsically Safe Entity - For Hazardous Locations  
Class I, Division 1, Groups A, B, C and D  
Ex ia IIC, Ga

CLASS 2258 84 - PROCESS CONTROL EQUIPMENT - Intrinsically Safe Entity - For Hazardous Locations - Certified to US Standards  
Class I, Division 1, Groups A, B, C and D  
Class I, Zone 0, AEx ia IIC, Ga

**Warning:**

Substitution of components may impair intrinsic safety.

The transmitters must be installed in a suitable enclosure to meet installation codes stipulated in the Canadian Electrical Code (CEC) or for US the National Electrical Code (NEC).

## Desenho de Instalação INMETRO



Para instalação segura do 5331A ou 5334A o seguinte deve ser observado. O modo deve apenas ser instalado por pessoas qualificadas que são familiarizadas com as leis nacionais e internacionais, diretrizes e padrões que se aplicam a esta área.

Ano de fabricação pode ser pego dos dois primeiros dígitos do número de série.

|             |  |
|-------------|--|
| Certificado | DEKRA 13.0001 X  |
| Indicação   | Ex nA [ic] IIC T4..T6 Gc<br>Ex ic IIC T4..T6 Gc<br>Ex ic IIIC Dc |

Padrões ABNT NBR IEC 60079-0 : 2008, ABNT NBR IEC 60079-11 : 2009,  
IEC 60079-15 : 2010, ABNT NBR IEC 60079-26 : 2008

|  |                          |                      |                       |
|--|--------------------------|----------------------|-----------------------|
| T4: $-40 \leq T_a \leq 85^\circ\text{C}$ | <b>Terminal: 3,4,5,6</b> | <b>Terminal: 1,2</b> | <b>Terminal: 1,2</b>  |
| T6: $-40 \leq T_a \leq 60^\circ\text{C}$ | Uo: 9,6 V                | Ex nA                | Ex ic                 |
|  | Io: 25 mA                |                      |                       |
|  | Po: 60 mW                | Umax =35 VDC         | Ui = 35 VDC           |
|  | Lo: 33 mH                |                      | Ii = 110 mA           |
|  | Co: 2,4 $\mu\text{F}$    |                      | Li = 10 $\mu\text{H}$ |
|  |                          |                      | Ci = 1,0 nF           |

### Notas para instalação

Para a instalação em uma atmosfera de gás potencialmente explosivo, se aplicam as instruções a seguir:

Para a instalação nA o transmissor deve ser instalado em um gabinete de metal, por exemplo, gabinete em forma B que forneça um grau de proteção de pelo menos IP54 de acordo com IEC60529 ou em um caixa com tipo de proteção Ex n ou Ex e.

Para a instalação IC o transmissor deve ser instalado em um invólucro proporcionando um grau de proteção de IP20, pelo menos, de acordo com a norma IEC60529 que é adequado para a aplicação.

Dispositivos de entrada de cabos e elementos de supressão devem cumprir os mesmos requisitos.

Para uma temperatura ambiente  $\geq 60^\circ\text{C}$ , os cabos resistentes ao calor precisam ser utilizados com uma classificação de pelo menos 20 K acima da temperatura ambiente.

Para a instalação em uma atmosfera de poeira potencialmente explosiva, se aplicam as instruções a seguir:

A temperatura da superfície do invólucro é igual à temperatura ambiente mais 20 K, para uma camada de pó, com uma espessura superior a 5 mm.

O transmissor deve ser montado em um invólucro de acordo com a norma DIN 43729, que proporciona um grau de proteção de, pelo menos, IP6X de acordo com a norma IEC60529, e que seja apropriado para a aplicação.

Dispositivos de entrada de cabos e elementos de supressão devem cumprir as mesmas exigências.



## Desenho de Instalação INMETRO



Para instalação segura do 5331D ou 5334B o seguinte deve ser observado. O modo deve apenas ser instalado por pessoas qualificadas que são familiarizadas com as leis nacionais e internacionais, diretrizes e padrões que se aplicam a esta área.  
Ano de fabricação pode ser pego dos dois primeiros dígitos do número de série.

Certificado .....DEKRA 13.0001 X

Indicação Ex ia IIC T6...T4 Ga  
Ex ia IIIC Da

Padrões ABNT NBR IEC 60079-0 : 2008 ABNT NBR IEC 60079-11 : 2009 IEC 60079-15 : 2010  
ABNT NBR IEC 60079-26 : 2008

### Áreas Perigosas

Zona 0, 1, 2, 20, 21, 22,

T4:  $-40 \leq T_a \leq 85^\circ\text{C}$

T5:  $-40 \leq T_a \leq 60^\circ\text{C}$

T6:  $-40 \leq T_a \leq 45^\circ\text{C}$

### Terminal: 3,4,5,6

Uo: 9,6 VDC

Io: 25 mA

Po: 60 mW

Lo: 33 mH

Co: 2,4 $\mu$ F

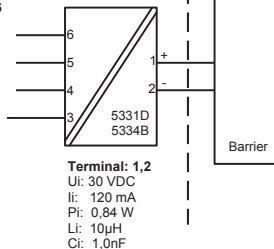

**Notas de instalação**

O circuito do sensor não é isolado galvanicamente infalível do circuito de entrada. Contudo, a isolação galvânica entre os circuitos é capaz de resistir a um teste de tensão de 500Vac durante 1 minuto.

Em uma atmosfera de gás potencialmente explosiva, o transmissor deve ser montado em um enclosure a fim de garantir um grau de proteção de no mínimo IP20 de acordo com EN60529. Se contudo o ambiente requer um nível de proteção maior, isso deve ser levado em conta

Se o transmissor é instalado em uma atmosfera explosiva exigindo o uso de equipamento de categoria Ga e se o enclosure é feito de alumínio, ele deve ser instalado de modo que, mesmo em caso de avaria rara, fontes de ignição devido a impacto e fricção, faíscas são eliminadas; se o enclosure é feito de materiais não metálicos, cargas eletroestáticas devem ser evitadas.

Para instalação em atmosfera de poeira potencialmente explosiva, as instruções a seguir:

O transmissor deve ser montado em enclosure de metal forma B de acordo com DIN43729 que está fornecendo um grau de proteção de pelo menos IP6X de acordo com EN60529. Isso é adequado para aplicação e corretamente instalado.

As entradas dos cabos e os elementos de obturação que podem ser utilizados são adequados para a aplicação e corretamente instalados.

Para temperatura ambiente  $\geq 60^{\circ}\text{C}$ , fios de resistência ao calor devem ser usados com uma faixa de pelo menos 20K acima da temperatura ambiente.

A temperatura da superfície do enclosure é igual à temperatura ambiente mais de 20 K, por uma camada de pó, com uma espessura até 5 mm.



**Displays** Programmable displays with a wide selection of inputs and outputs for display of temperature, volume and weight, etc. Feature linearization, scaling, and difference measurement functions for programming via PReset software.



**Ex interfaces** Interfaces for analog and digital signals as well as HART signals between sensors / I/P converters / frequency signals and control systems in Ex zone 0, 1 & 2 and for some devices in zone 20, 21 & 22.



**Isolation** Galvanic isolators for analog and digital signals as well as HART signals. A wide product range with both loop-powered and universal isolators featuring linearization, inversion, and scaling of output signals.





























**Temperature** A wide selection of transmitters for DIN form B mounting and DIN rail devices with analog and digital bus communication ranging from application-specific to universal transmitters.



**Universal** PC or front programmable devices with universal options for input, output and supply. This range offers a number of advanced features such as process calibration, linearization and auto-diagnosis.



- 
 [www.preelectronics.fr](http://www.preelectronics.fr)  
 [sales-fr@preelectronics.com](mailto:sales-fr@preelectronics.com)
- 
 [www.preelectronics.de](http://www.preelectronics.de)  
 [sales-de@preelectronics.com](mailto:sales-de@preelectronics.com)
- 
 [www.preelectronics.es](http://www.preelectronics.es)  
 [sales-es@preelectronics.com](mailto:sales-es@preelectronics.com)
- 
 [www.preelectronics.it](http://www.preelectronics.it)  
 [sales-it@preelectronics.com](mailto:sales-it@preelectronics.com)
- 
 [www.preelectronics.se](http://www.preelectronics.se)  
 [sales-se@preelectronics.com](mailto:sales-se@preelectronics.com)
- 
 [www.preelectronics.com](http://www.preelectronics.com)  
 [sales-uk@preelectronics.com](mailto:sales-uk@preelectronics.com)
- 
 [www.preelectronics.com](http://www.preelectronics.com)  
 [sales-us@preelectronics.com](mailto:sales-us@preelectronics.com)
- 
 [www.preelectronics.cn](http://www.preelectronics.cn)  
 [sales-cn@preelectronics.com](mailto:sales-cn@preelectronics.com)
- 
 [www.preelectronics.be](http://www.preelectronics.be)  
 [sales-be@preelectronics.com](mailto:sales-be@preelectronics.com)

## Head office

Denmark  
 PR electronics A/S  
 Lerbakken 10  
 DK-8410 Rønde

[www.preelectronics.com](http://www.preelectronics.com)  
[sales@preelectronics.dk](mailto:sales@preelectronics.dk)  
 tel. +45 86 37 26 77  
 fax +45 86 37 30 85



QUALITY SYSTEM AND ENVIRONMENTAL MANAGEMENT SYSTEM  
 DS/EN ISO 9001  
 DS/EN ISO 14001

